

Visit www.clickacademy.co for important video education on Click Reels and RevoSurface designs



Advisories

Must be installed by a licensed professional.
 Overtightening could compromise circulation.
 Lace will wear:

- Routinely check for wear or damage.
- Look for broken fibers around areas of high wear.
- Replace lace if a significant amount of fibers are broken.
- Proactively replace lace every 6 months.
- Keep lace away from open flame and sharp edges.

Weight limit: 300lbs/135kg

See instructions in other languages: clickmedical.co/instructions

GUARANTEE

The Click Reel is guaranteed to last the life of the device into which it is originally installed. Registration of the Click Reel is required at the time of original device delivery. To register: clickmedical.co/contact-us/cr-registration/

WARRANTY

For warranty information on all of Click Medical's products: clickmedical.co/terms/#warranty

U.S. Customers:

Contact Help@ClickMedical.co
 Tel: +1-970-670-7012

International Customers:

Please contact your local distributor.

Click Medical products are patent protected.

For full list see www.clickmedical.co/patents

RevoSurface® Tool Kit Contents:

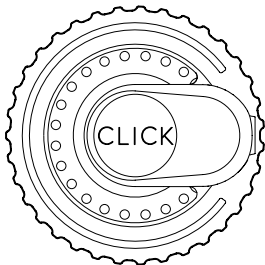

Click Reel

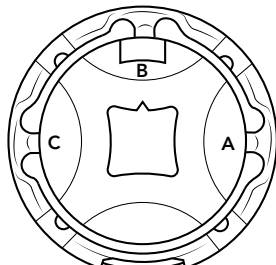

Surface Collar



Surface Shim

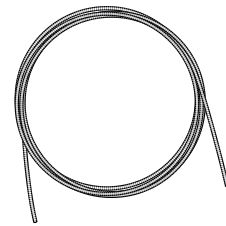

1.8m
Lamination Tube

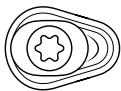

Surface Guide +
Attachment Screw x 10

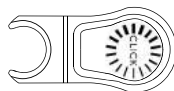

Releasing Tab
x 5

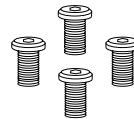

Phillips Head
Screw x 4

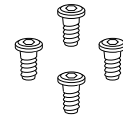

Torx Head
Screw x 4

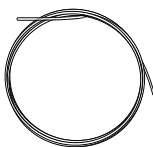

2.0m
HC Lace



Plastic Lace
Feeder x 3

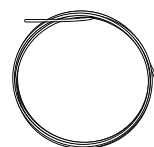

Metal Lace
Feeder



Reel Tool

Select the Application

Thermoplastic

Use these instructions if you are building a thermoplastic diagnostic prosthesis

Option 1:

System wrapped in fiberglass for higher precision and durability or extended use

[Go to Page 3](#)

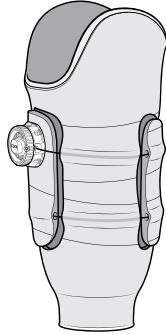

Option 2:

System fastened with externally mounted hardware to quickly build and assess an adjustable design

[Go to Page 7](#)

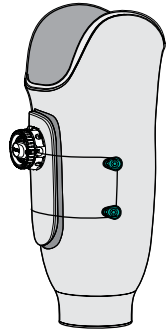

3D Print

Use these instructions if you are building a 3D printed device

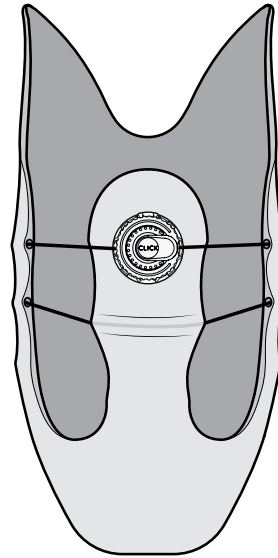

[Go to Page 13](#)

Orthotics

Use these instructions if you are building an orthosis with adjustability

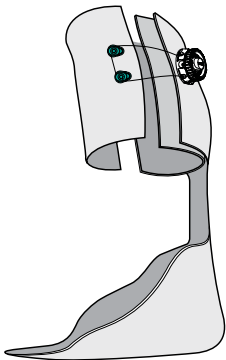

[Go to Page 7](#)



Modifying an Existing Device

Use these instructions if you are adding adjustability to an existing device

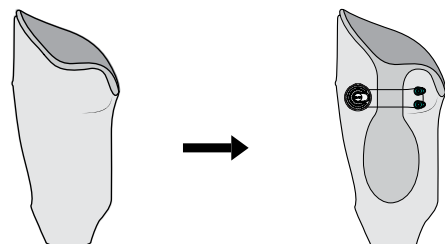
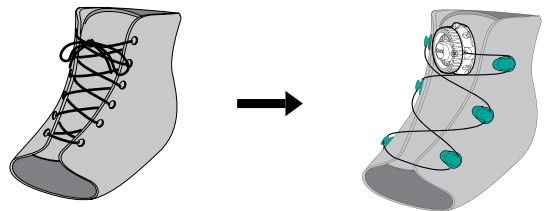

[Go to Page 7](#)

RevoSurface Thermoplastic Diagnostic Wrapped in Fiberglass:

Thermoplastic

Use these instructions if you are building a thermoplastic diagnostic prosthesis

System wrapped in fiberglass for higher precision and durability or extended use

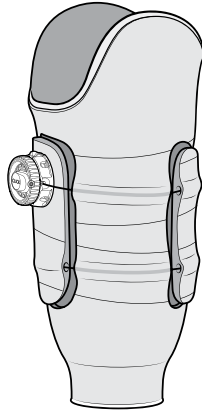

Fabrication Overview:

1. Determine adjustable design type: Panel, Gap, Hinge.
2. Determine areas of adjustment and location of Click Reel.
3. Pull flexible insert material over mold.
4. Pull plastic over insert.
5. Draw areas of adjustment and location of Click Reel on device.
6. Attach RevoSurface components to device.
7. Wrap all parts of the system in cast tape.
8. Cut trim lines and areas of adjustment.
9. Sand and finish edges.
10. Apply pad material.
11. Lace device.
12. Select Reel Mode - Power Mode with Red Lock Plugs in or Shift Mode with Red Lock Plugs removed.
13. Install Click Reel and test for function.
14. Deliver to patient and optimize fit.

For material suggestions and guidelines, please refer to the **Material Data Sheet:** clickmedical.co/mds

Determine Adjustable Design Type:

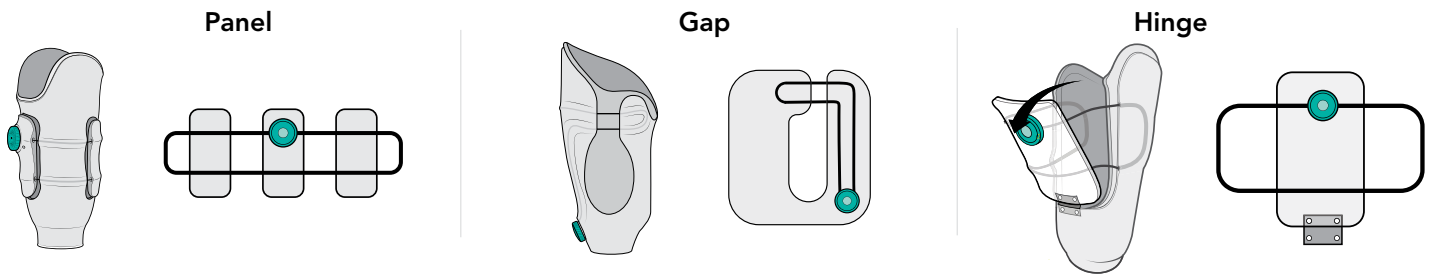

Additional Designs: To learn more about designing adjustable RevoFit devices, enroll in ClickAcademy.co

Detailed Fabrication Instructions:

- 1** Pull insert material over mold.

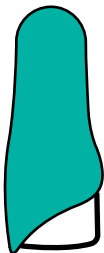

- 2** Pull plastic.



- 3** Remove device from model and attach necessary hardware to test on the patient.

- a. Verify volume and fit.

- 4** Determine location of Click Reel:

- a. Discuss with the patient where they would like the reel. Consider range of motion and accessibility.

- 5** Determine ideal adjustment areas

For Panel and Hinge designs:

1. Insert pads of approximate size and thickness into the device (one at a time) and don the device onto the patient.
2. Get feedback from the patient about fit.
3. Adjust pad size, position, and thickness as needed.
4. Mark final pad location, size and thickness on the device.

For Gap designs:

1. Determine the gap size and location.
2. Mark on device.

Detailed Fabrication Instructions:

6 Draw lace routing onto socket:

PANEL DESIGN RULE:

- $\frac{1}{4}$ rule = length of panel $\div 4$. Tube must be $\frac{1}{4}$ distance from top/bottom edges.
- Tubes must cross panel parallel to each other.
- Tube must cross panel at a perpendicular angle to edge.
- Tube must extend 1cm on the frame before turning.

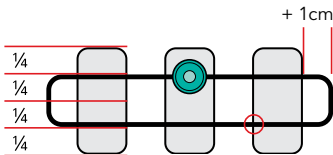

GAP DESIGN RULE:

- Tubes must cross gap parallel with each other.
- Tube must cross gap at a perpendicular angle to edge.
- Tube must extend straight 1cm on the frame before turning.

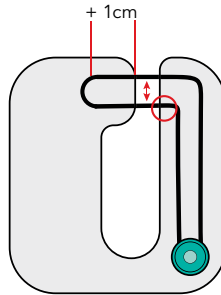

HINGE DESIGN RULE

- Use $\frac{1}{4}$ rule to determine where to route closure points.
- Tube must extend 1cm on the frame before turning.
- Hinge must be at a different level (in the transverse plane) than closure points.

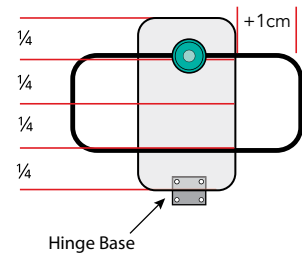

7 Align tube ports with lace path and bond or screw Surface Collar to device.

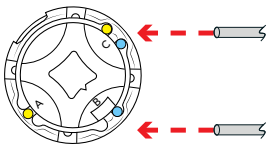

For parallel lace path:
Use blue ports B and C

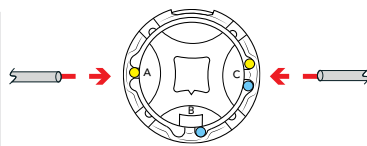

For opposite lace path:
Use yellow ports A and C

8 Glue tube to device frame.

- Cut tube at angle and insert 2cm into collar.
- Glue along designated path with dots of super glue about every 2cm.
- DO NOT KINK THE TUBE -
If the tube kinks, you must replace with a new piece.
- Cut the other end of the tube to length and insert 2cm into collar.

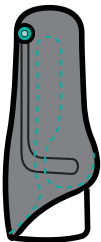
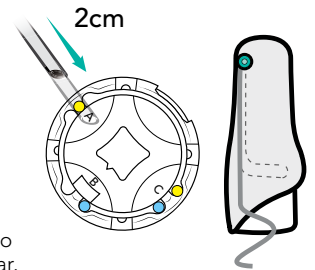

- ### 9 Take photo of trim lines and areas of adjustment for future reference.

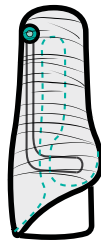

- ### 10 Sand surface and wrap entire system with cast tape.
- Hint:** Immediately wrap with cling wrap to ensure a tight bond and smooth finish.

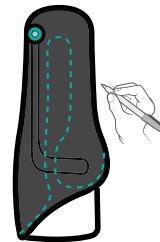

- ### 11 Re-draw trim lines and areas of adjustment.
- Use photo from Step 8 for reference.

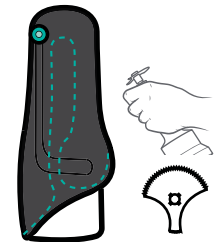

- ### 12 Cut trim lines.
- Use small end of segmented cast saw blade for tight turns.

13 Finish edges of frame and/or panels:

- Sand edges.
- Clear tube ends of debris.
- Buff edges smooth with 1000 grit sandpaper.

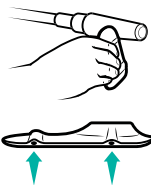

14 Prepare collar:

- Cut out fiberglass material covering the collar.
- Trim tube ends and clear debris.



15 Add pad material to panels or hinge designs.

For more information in pad optimization, enroll in [Click Academy](#).

Pad Shape:
Flat or slightly convex shape which allows for better application of pressure.

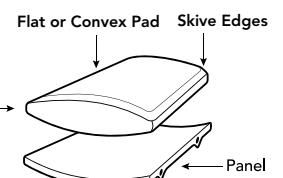

16 Lace device.

Start at the collar and use the lace feeder to pull lace through the device.

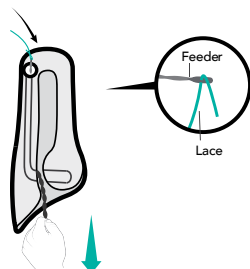

Detailed Fabrication Instructions (continued):

17 Attach lace to the Click Reel:

Step 1

Ensure that the reel is ready for lacing. Both lock plugs should be in place. The **green marks** on the spool should align with the **green marks** on the washer. If necessary, turn dial to align **green marks**.

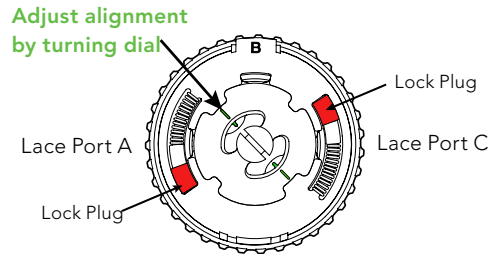

Step 2

Relace the device. Attach each lace to its corresponding lace port on the reel - A, B, or C.

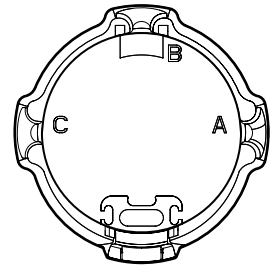

Step 3

Lace the reel using the plastic lace feeder.

Pro Tip:

Gently pull the lace through the cavity to avoid breaking the plastic lace feeder.

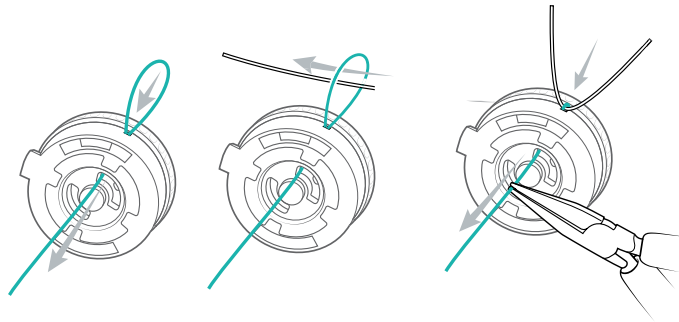

Step 4

Tie a **double overhand knot** and trim tail to ~5mm and lightly burn the end of the tail.

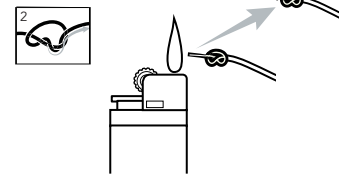

Step 5

Pull lace to seat knot in the far lace pocket, on the opposite side of the **green marker**.

Completely push knot into the cavity with a #1 flathead screwdriver:

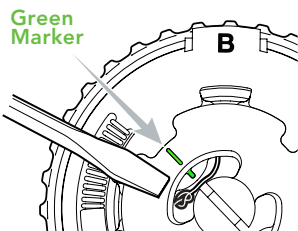

Step 6

Pull open lace end to remove loose lace from device.

Repeat Step 3 to feed open lace end through reel.

Measure out ~10cm of lace.

Repeat Step 4 to tie double overhand knot, trim and seat it.

Step 7

Decide which reel mode to activate:

For more information on reel modes, watch our video here: <https://vimeo.com/786989811>

ADJUSTABLE DESIGNS WITH Less than 3" of lace uptake

75% of Applications

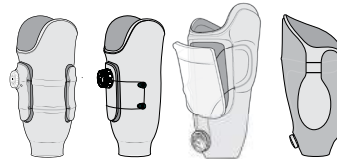

Keep Red Lock Plugs installed in the reel.

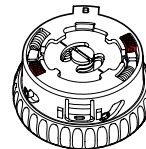

ADJUSTABLE DESIGNS WITH More than 3" of lace uptake

25% of Applications

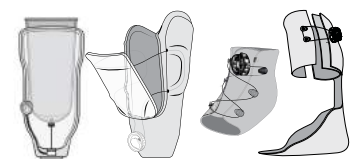

Remove Red Lock Plugs after lacing the reel.

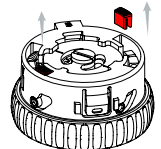

Pro Tip: Central fabricators should deliver device with Red Lock Plugs installed in reel. This will allow the practitioner to decide if they want Power Mode or Shift Mode.

18 Install the Click Reel:

1. Insert the foot of the reel into the void in the bottom of the collar opposite of the metal insert.
2. Press the reel firmly into the collar (you should hear a "CLICK" when secure).

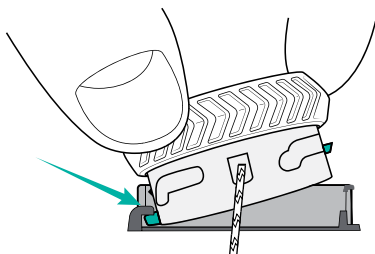

19 Test function.

Cycle the system 3 times before delivering to verify proper function.

20 Important.

As a final step of fabrication, attach the patient **Instructions For Use** hangtag on dial.

How to use the Click Reel

The reel can operate in either Power Mode or Shift Mode.

If you want to change between modes, see our video on the process here: <https://vimeo.com/786989811>

How to operate the Click® Reel in **Power Mode - With Red Lock Plugs**

- 1 Turn the dial clockwise to tighten to desired tension.
- 2 Turn the dial counterclockwise to release tension.
- 3 Micro-adjust as needed.

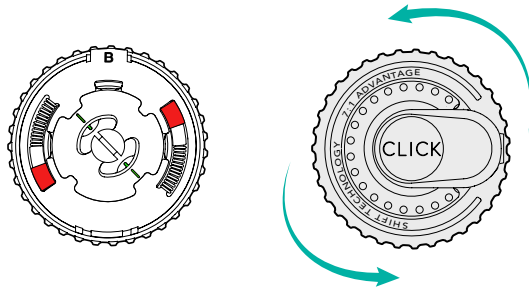

If the reel always clicks when turned, it is in Power Mode

How to operate the Click® Reel in **Shift Mode - Without Red Lock Plugs**

- 1 Turn reel clockwise to quickly take up lace.
- 2 Continue to turn the dial. It will automatically shift from "silent" to "clicking".
- 3 Micro-adjust by turning forward or backward.
- 4 To fully release lace, unwind counterclockwise until "clicking" stops. Lace will then freely release from the reel.



Reel will operate silently while taking up lace

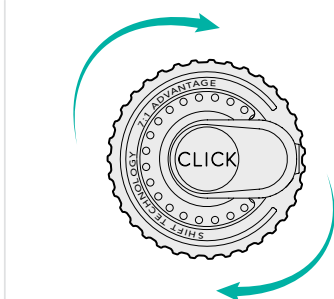

Once clicking, the reel will maintain lace tension and wind up the lace with higher precision, enabling a more customized fit



To remove the Click Reel:

- Locate the metal insert.
- Insert a small #1 flathead screwdriver between the metal insert and the reel body.
- Gently pry the reel upwards.

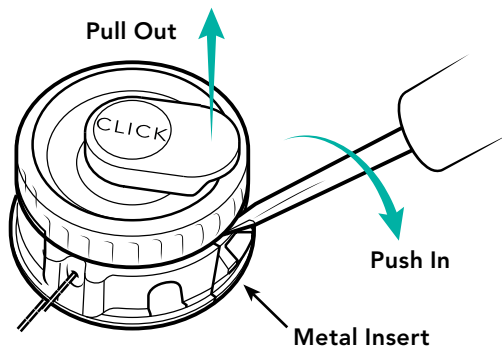

See clickmedical.co/instructions for detailed video instructions for replacing/re-lacing a reel.

Teach your patients to care for and maintain their RevoSurface® system:

Regularly inspect your RevoSurface system.



Inspect lace:

- ✓ Check for wear or damage routinely
- ✓ Replace at any sign of wear
- ✓ Replace lace every 6 months



This product is waterproof and submersible. Rinse with fresh water after use in saltwater, sand, or mud.

UK REP MDSS-UK RP LIMITED, 6 Wilmslow Road
Rusholme, M14 5TP Manchester
United Kingdom

CH REP MDSS CH GmbH, Laurenzenvorstadt 61
5000 Aarau, Switzerland

MD MDSS GmbH, Schiffgraben 41
30175 Hannover, Germany

EC REP



Click Medical, LLC, 1205 Hilltop Parkway, W101
Steamboat Springs, CO 80487, USA +1-970-670-7012

Thermoplastic

Use these instructions if you are building a thermoplastic diagnostic prosthesis system fastened with **externally mounted hardware** to quickly build and assess an adjustable design

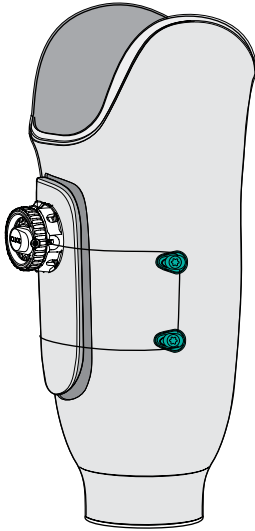

Orthotics

Use these instructions if you are building an orthosis with adjustability

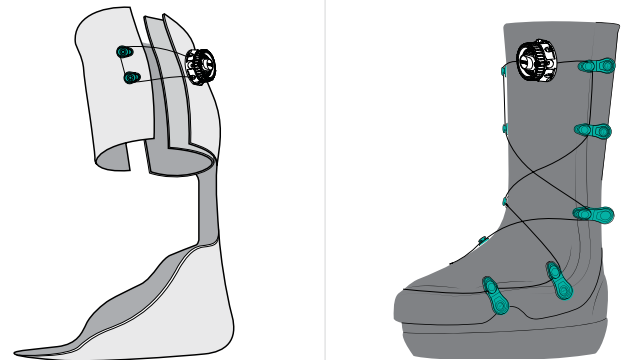

Modifying an Existing Device

Use these instructions if you are adding adjustability to an existing device

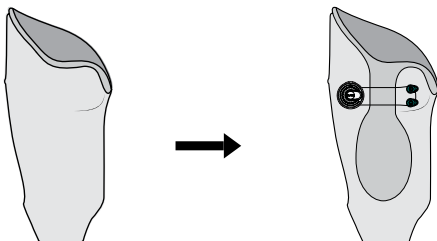
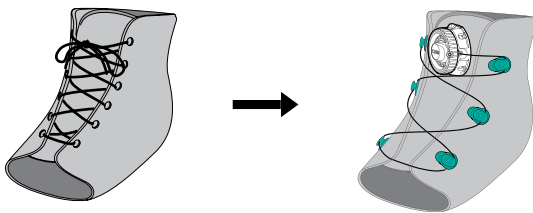

Fabrication Overview:

1. Determine adjustable design type: Strap or Lacer.
2. Determine areas of adjustment and location of Click Reel.
3. Determine likely lace guide placements and mark their location on the device.
4. Attach RevoSurface components to device.
5. Lace device.
6. Select Reel Mode - Power Mode with Red Lock Plugs in or Shift Mode with Red Lock Plugs removed.
7. Install Click Reel and test for function.
8. Deliver to patient and optimize fit.

For material suggestions and guidelines, please refer to the **Material Data Sheet**: clickmedical.co/mds

Pick a Design:

Additional Designs: To learn more about designing adjustable RevoSurface® devices, enroll in [ClickAcademy.co](https://www.clickacademy.co)

Strap

There are 3 strap configurations to choose from:

1 Simple Straps

For volume adjustments and simple don/doff.

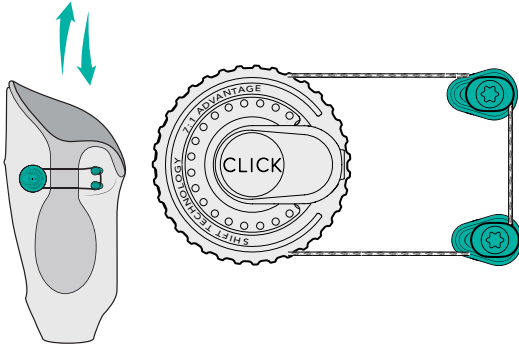

2 Releasing Straps

For fully opening.

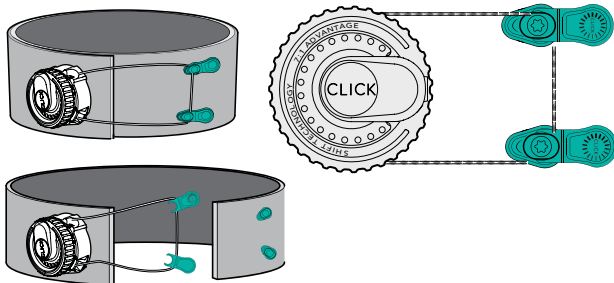

3 Dynamic Straps

For fitting conical shapes or closing a larger device.

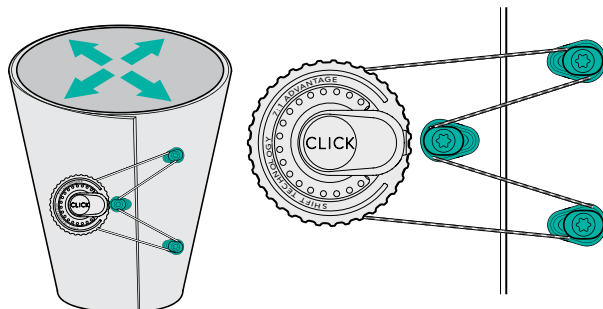

Dynamic strap can also be made with releasing guides to fully open.

Lacer

There are 2 lacer configurations to choose from:

1 Fixed Lacer

For easily slipping on/off the body.

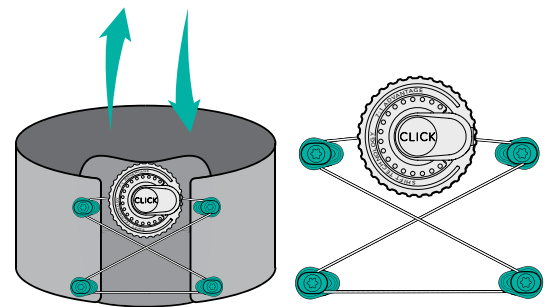

2 Releasing Lacer

For fully opening a device.

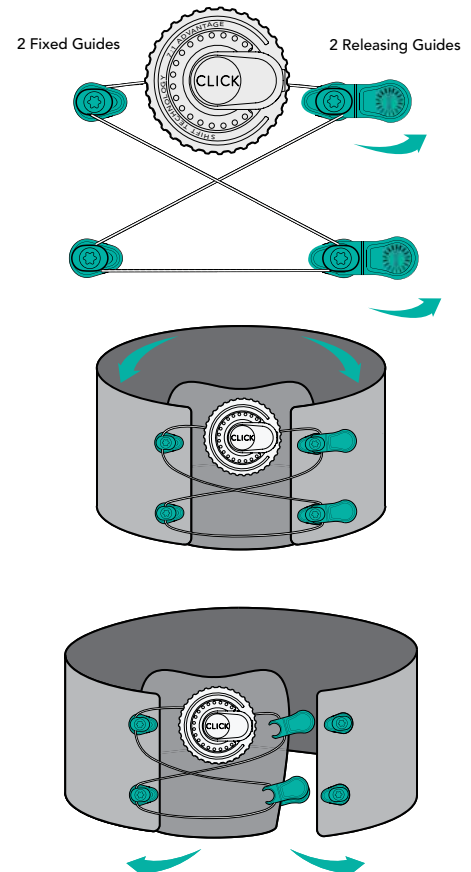

Planning the Configuration:

- 1 For all designs, first determine the trim lines of the device and sketch on device.
- 2 Next, determine where you want to place the Click Reel:
 - a. Make sure it is in line with your likely lace path.
 - b. Ensure that the reel will be easily accessible by the patient.
 - c. Place the Click Reel so it will not protrude and catch on clothing or edges.



- 3 Optimize the design:
 - a. Determine likely lace guide placements and mark their location on the device.
 - b. Optimize the lace angles.
 - c. Pair guides where possible to span larger areas.

For the Dynamic Strap:

Place the middle guide close to the reel to create optimal lace angles.

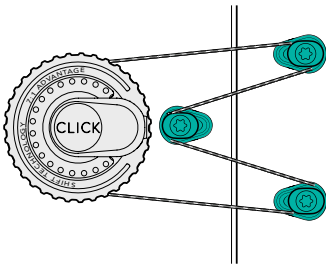

For the Simple Strap:

Parallel laces are best.

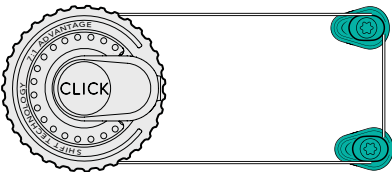

Place guides such that the lace angles are as minimal as possible to create optimum closure force.

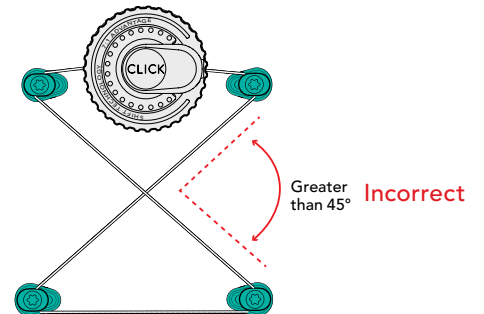
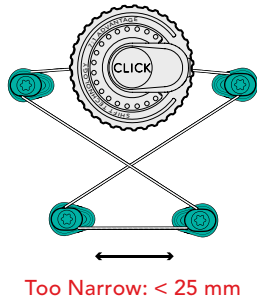
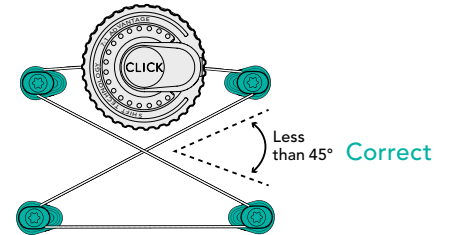
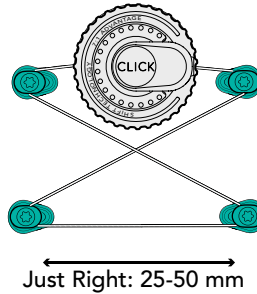

Single guides create closure over a smaller area.

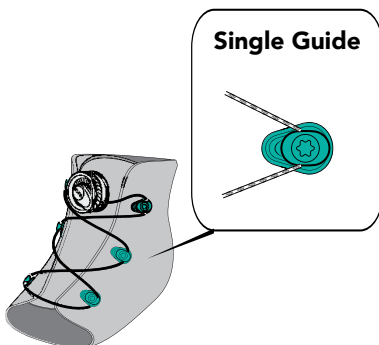

Paired guides span larger distances.

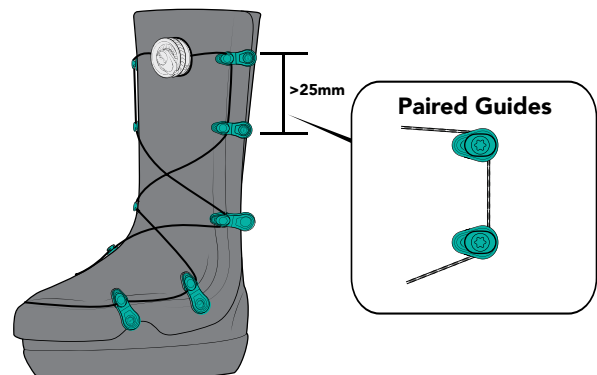

! Plan your configuration well before starting to mount components!
It will save you time later.

Fabricating the Device:

1 Mount the Surface Collar:

- Determine ideal placement.
- Grind a small flat area or apply the Surface Shim.
- Mark and drill the necessary holes, using a 3mm drill bit for Phillips head screws and a 1mm drill bit for Torx head screws.
- Attach with the included hardware.

Note:

- If running laces in parallel, use lace ports **B** and **C**.
- If running laces opposite, use lace ports **A** and **C**.

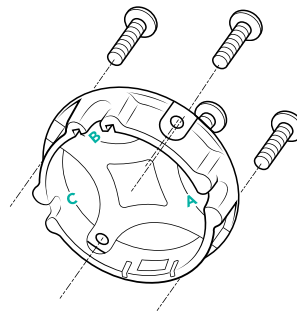

Mount from the **inside** of device with the **Phillips** head screws.

OR

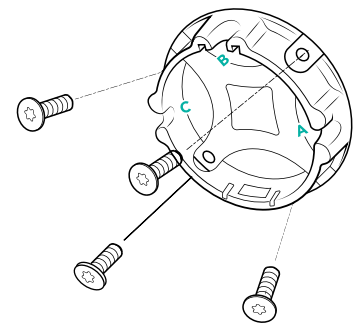

Mount from the **outside** of the device, using **Torx** head screws.

Note: Make sure screw heads don't interfere with reel installation.

2 Mount the lace guides:

- Drill 5 mm holes into device at desired guide locations.
- Orient the guides.

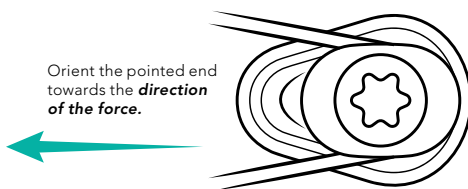

- Arrange the top cap into the **Fixed** or **Releasing** position.

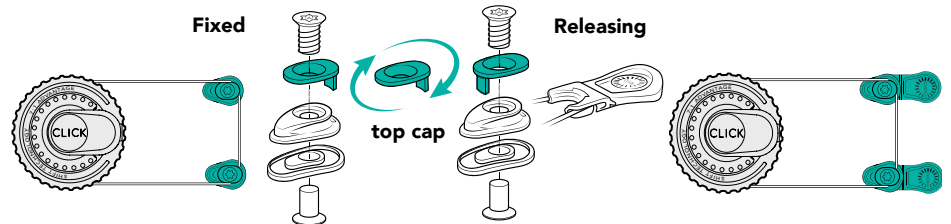

- Attach with included hardware or rivet (not included).

3 Lace the device.

Start at the collar and lace through guides.

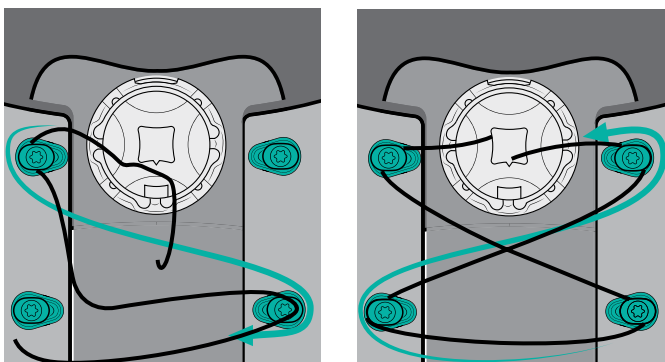

PROPER fixed guide lacing:



IMPROPER fixed guide lacing:

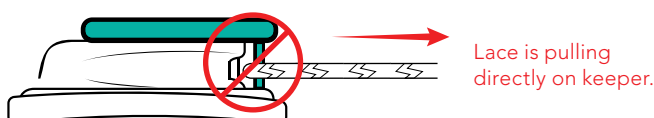

For releasing guides, simply wrap lace around guide until you install the releasing handle.

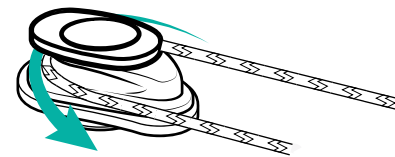

Add releasing handles to the lace (if configuring releasing guides).

Feed lace through **OR** Snap handle onto the lace

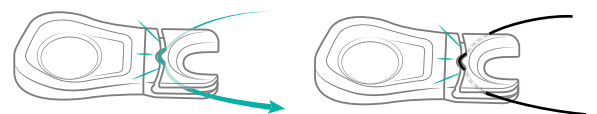

Then slide the handle onto each releasing guide base.

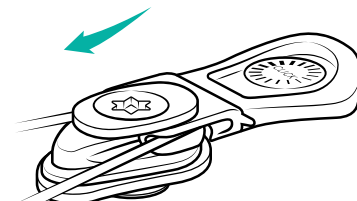

4 Attach lace to the Click Reel.

Step 1

Ensure that the reel is ready for lacing. Both lock plugs should be in place. The **green marks** on the spool should align with the **green marks** on the washer. If necessary, turn dial to align **green marks**.

Adjust alignment by turning dial

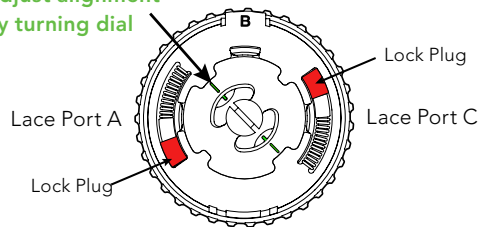

Step 2

Relace the device. Attach each lace to its corresponding lace port on the reel - A, B, or C.

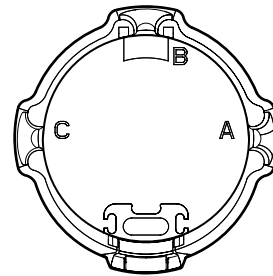

Step 3

Lace the reel using the plastic lace feeder.

Pro Tip:

Gently pull the lace through the cavity to avoid breaking the plastic lace feeder

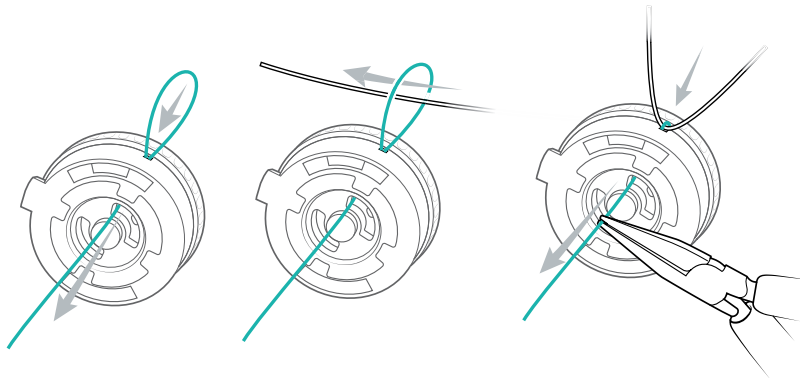

Step 4

Tie a **double overhand** knot and trim tail to ~5mm and lightly burn the end of the tail.

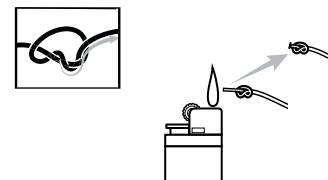

Step 5

Pull lace to seat knot in the far lace pocket, on the opposite side of the **green marker**.

Completely push knot into the cavity with a #1 flathead screwdriver:

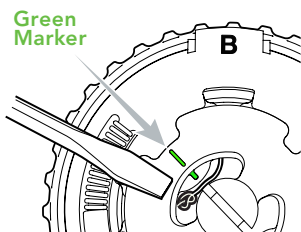

Step 6

Pull open lace end to remove loose lace from device.

Repeat Step 3 to feed open lace end through reel.

Measure out ~10cm of lace.

Repeat Step 4 to tie double overhand knot, trim and seat it.

Step 7

Decide which reel mode to activate:

For more information on reel modes, watch our video here: <https://vimeo.com/786989811>

ADJUSTABLE DESIGNS WITH Less than 3" of lace uptake

75% of Applications

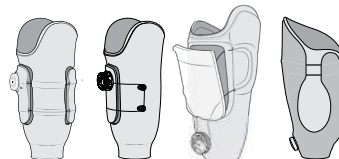

Keep Red Lock Plugs installed in the reel.

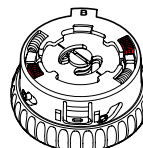

ADJUSTABLE DESIGNS WITH More than 3" of lace uptake

25% of Applications

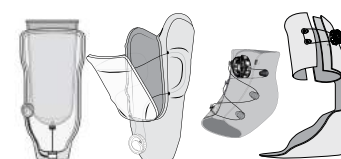

Remove Red Lock Plugs after lacing the reel.

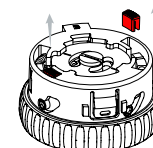

Pro Tip: Central fabricators should deliver device with Red Lock Plugs installed in reel. This will allow the practitioner to decide if they want Power Mode or Shift Mode.

18 Install the Click Reel:

1. Insert the foot of the reel into the void in the bottom of the collar opposite of the metal insert.
2. Press the reel firmly into the collar (you should hear a "CLICK" when secure).

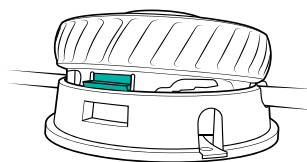
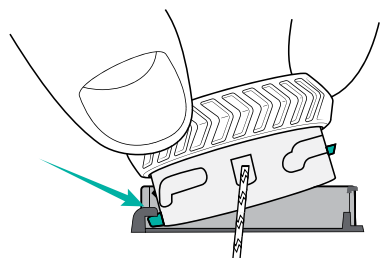

CLICK!

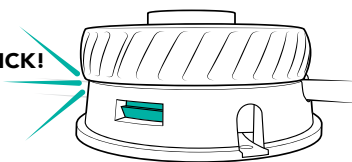

19 Test function.

Cycle the system 3 times before delivering to verify proper function.

20 Important.

As a final step of fabrication, attach the patient **Instructions For Use** hangtag on dial.

How to use the Click Reel

The reel can operate in either Power Mode or Shift Mode.
If you want to change between modes, see our video on the process here: <https://vimeo.com/786989811>

How to operate the Click® Reel in **Power Mode - With Red Lock Plugs**

- 1 Turn the dial clockwise to tighten to desired tension.
- 2 Turn the dial counterclockwise to release tension.
- 3 Micro-adjust as needed.

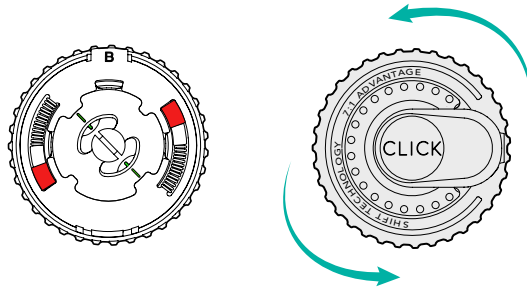

If the reel always clicks when turned, it is in Power Mode

How to operate the Click® Reel in **Shift Mode - Without Red Lock Plugs**

- 1 Turn reel clockwise to quickly take up lace.
- 2 Continue to turn the dial. It will automatically shift from "silent" to "clicking".
- 3 Micro-adjust by turning forward or backward.
- 4 To fully release lace, unwind counterclockwise until "clicking" stops. Lace will then freely release from the reel.



Reel will operate silently while taking up lace



Once clicking, the reel will hold lace tension and wind up lace at a higher power

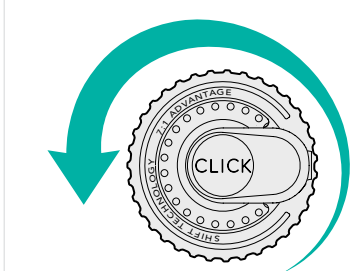
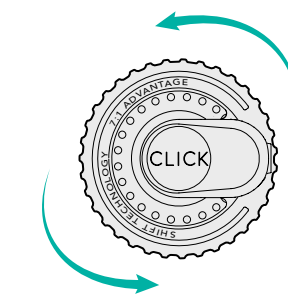

Teach your patients how to release and reconnect the releasing guides:

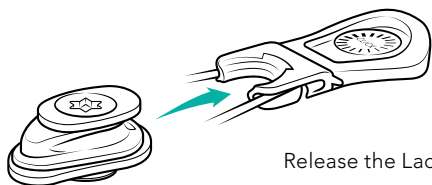

Release the Lace.

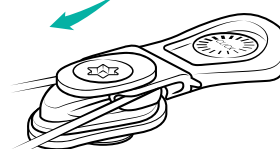

Reconnect the Lace.

To remove the Click Reel:

1. Locate the metal insert.
2. Insert a small #1 flathead screwdriver between the metal insert and the reel body.
3. Gently pry the reel upwards.

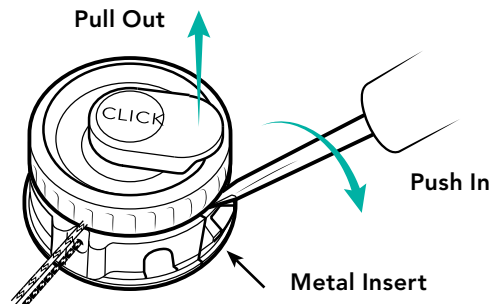

See clickmedical.co/instructions for detailed instructions for replacing/re-lacing a reel.

At delivery of device with patient present, scan *Instructions For Use* Hangtag. Please review with your patient how to use the Click Reel and to care for and maintain their RevoSurface system.

Regularly inspect your RevoSurface system.



Inspect lace:

- ✓ Check for wear or damage routinely
- ✓ Replace at any sign of wear
- ✓ Replace lace every 6 months



This product is waterproof and submersible. Rinse with fresh water after use in saltwater, sand, or mud.

Adding Adjustability to your 3D Printed Device

3D Print

Use these instructions if you are building a 3D printed device

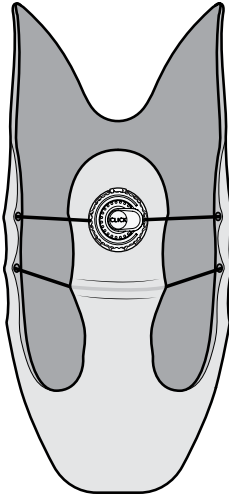

Fabrication Overview:

1. Pick a Panel, Gap or Hinge design.
2. Locate areas of desired adjustment and placement of reel.
3. Download the reel mounting geometry from Click Academy and then integrate into the CAD model.
4. Integrate the lace paths or locations of Surface Guides into the CAD model.
5. Print device.
6. Apply the RevoSurface components.
7. Test device for function.

For material suggestions and guidelines, please refer to the **Material Data Sheet**: clickmedical.co/mds

Determine Adjustable Design Type:

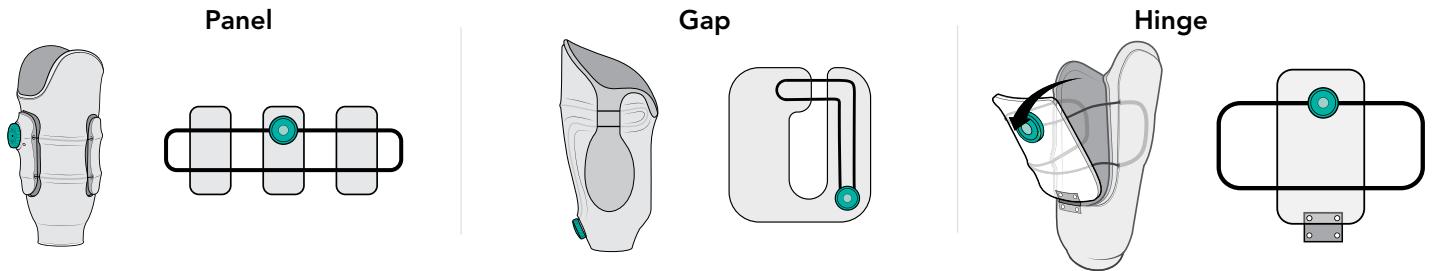

Additional Designs: To learn more about designing adjustable RevoSurface devices, enroll in ClickAcademy.co

Draw lace routing onto socket:

PANEL DESIGN RULE:

- $\frac{1}{4}$ rule = length of panel \div 4. Tube must be $\frac{1}{4}$ distance from top/bottom edges.
- Tubes must cross panel parallel to each other.
- Tube must cross panel at a perpendicular angle to edge.
- Tube must extend 1cm on the frame before turning.

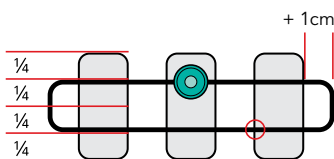

GAP DESIGN RULE:

- Tubes must cross gap parallel with each other.
- Tube must cross gap at a perpendicular angle to edge.
- Tube must extend straight 1cm on the frame before turning.

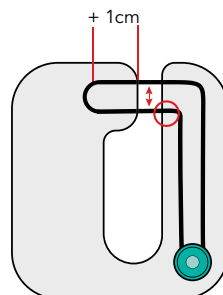

HINGE DESIGN RULE

- Use $\frac{1}{4}$ rule to determine where to route closure points.
- Tube must extend 1cm on the frame before turning.
- Hinge must be at a different level (in the transverse plane) than closure points.

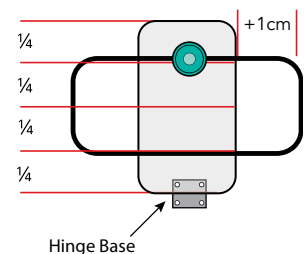

Integrating the Reel Mounting Geometry:

- 1 Download the dummy file for the Reel mounting geometry. To access this file, please enroll or login to Click Academy. The file can be found in the RevoSurface Build It course.



- 2 Integrate the reel mounting geometry into the model of your device.

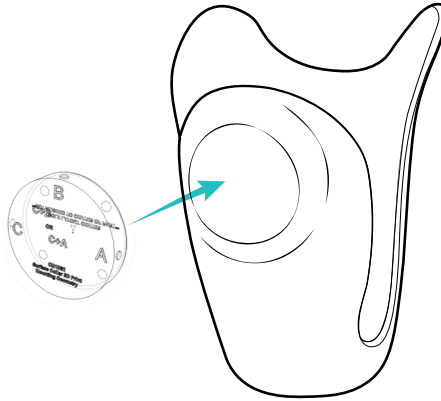

- 3 Rotate the geometry to align the lace exits with the lace path.

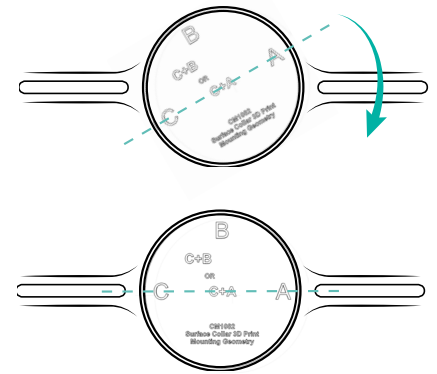

Creating Lace Path with Surface Guides:

4 OPTION 1 Placing and Installing Surface Guides:

Why use Surface Guides?

1. They are easy to place after printing.
2. They can simplify the 3D design process.
3. They allow for lace path optimization after printing.

Paired guides span larger distances.

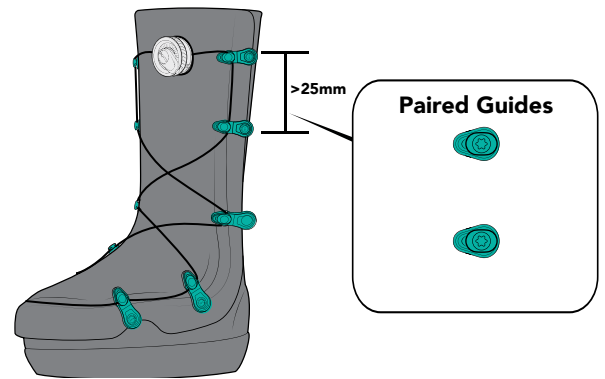

Step 1

After printing, identify the lace path and surface guide locations by using these guidelines:

Pair Lace Guides to create lace paths

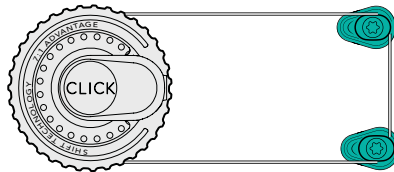

Step 2

Mark the location of each Surface Guide screw hole on the device

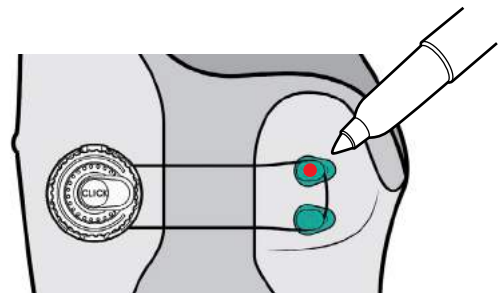

Step 3

Drill 3mm holes to accept the Surface Guides

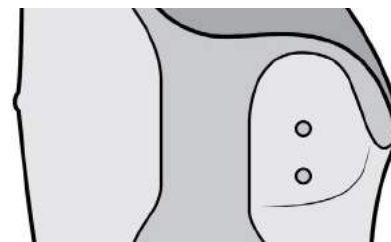

Creating Integrated Lace Path Geometry:

4 OPTION 2 Creating Lace Channels:

Why integrate the lace path?

Creating 3D printed lace paths have the advantage of streamlined integration and a lower profile. However, this technique is more complicated, so we suggest using this method only after you have gained experience creating and printing adjustable designs.

Step 1

Create tubing channels with an inner diameter of 3.2mm so that the tubing can be inserted into the device.

The tubing is required as it protects the lace and significantly reduces lace friction.

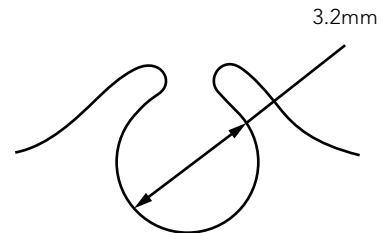

Step 2

Create open lace paths along the device to allow for printing medium to be cleaned out of lace paths.

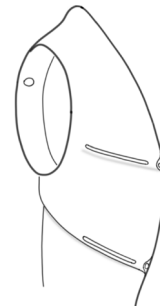

Step 3

At the end of each open lace path, close off the entire 360-degree path for ~5mm to fully capture the tube.

This prevents deformation of the tubing during device use.

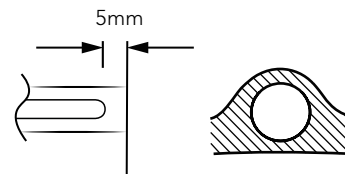

Step 4

If you enclose the lace path in the middle of the lace path for printing support or durability, keep the enclosed areas relatively short, less than 3cm.

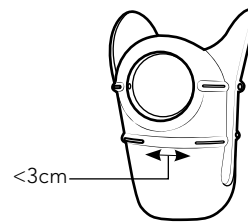

Step 5

Ensure that lace tracks will be well aligned once the device is tightened. This will greatly increase lace life in the device.

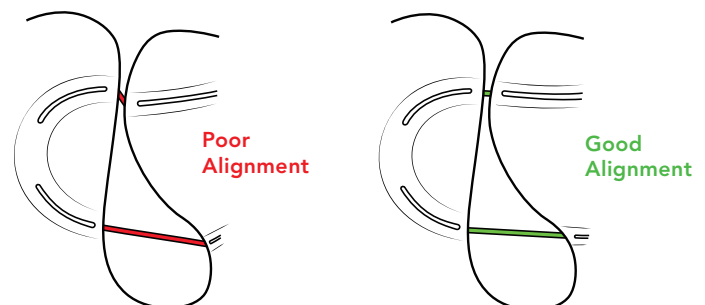

Fabricating the Device:

5 Mount the Surface Collar:

- Determine ideal placement.
- Grind a small flat area or apply the Surface Shim.
- Mark and drill the necessary holes, using a 3mm drill bit for Phillips head screws and a 1mm drill bit for Torx head screws.
- Attach with the included hardware.

Note:

- If running laces in parallel, use lace ports **B** and **C**.
- If running laces opposite, use lace ports **A** and **C**.

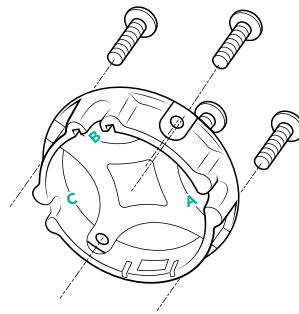

Mount from the **inside** of device with the **Phillips** head screws.

OR

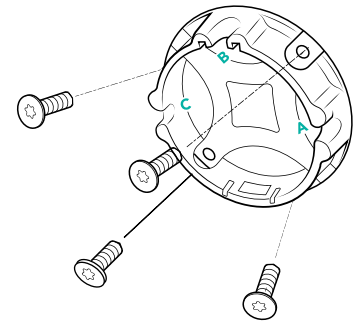

Mount from the **outside** of the device, using **Torx** head screws.

Note: Make sure screw heads don't interfere with reel installation.

6 Mount the lace guides:

- Drill 5mm holes into device at desired guide locations.
- Orient the guides.

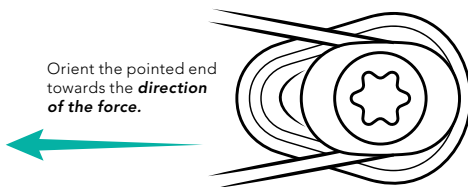

- Arrange the top cap into the **Fixed** or **Releasing** position.

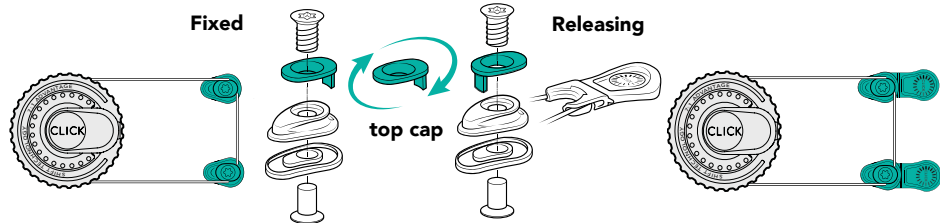

- Attach with included hardware or rivet (not included).

7 Lace the device.

Start at the collar and lace through guides.

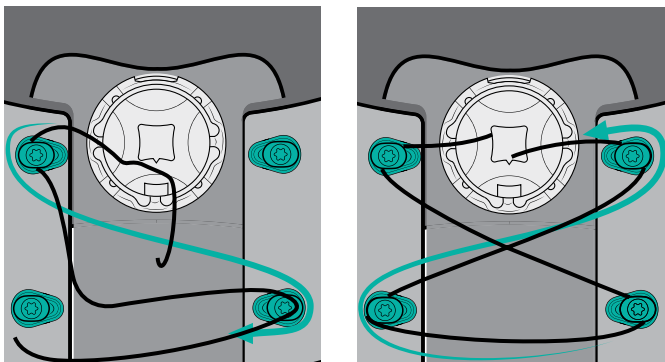

PROPER fixed guide lacing:



IMPROPER fixed guide lacing:

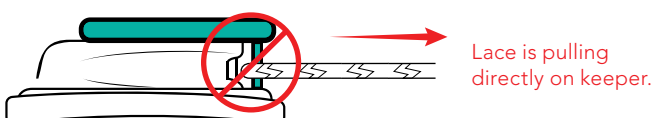

For releasing guides, simply wrap lace around guide until you install the releasing handle.

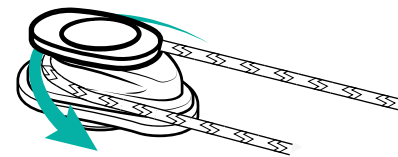

Add releasing handles to the lace (if configuring releasing guides).

Feed lace through **OR** Snap handle onto the lace

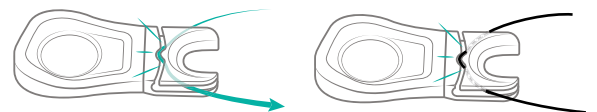

Then slide the handle onto each releasing guide base.

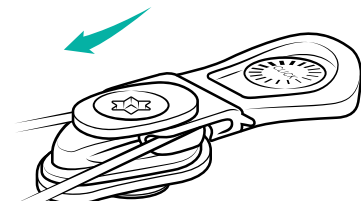

8 Attach lace to the Click Reel.

Step 1

Ensure that the reel is ready for lacing. Both lock plugs should be in place. The green marks on the spool should align with the green marks on the washer. If necessary, turn dial to align green marks.

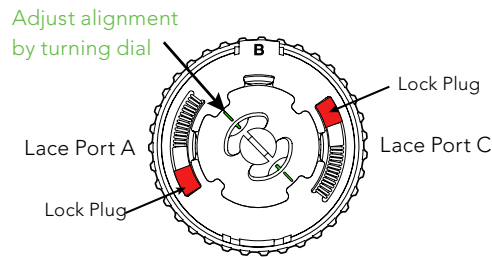

Step 2

Relace the device. Attach each lace to its corresponding lace port on the reel - A, B, or C.

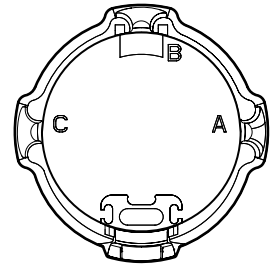

Step 3

Lace the reel using the plastic lace feeder.

Pro Tip:

Gently pull the lace through the cavity to avoid breaking the plastic lace feeder

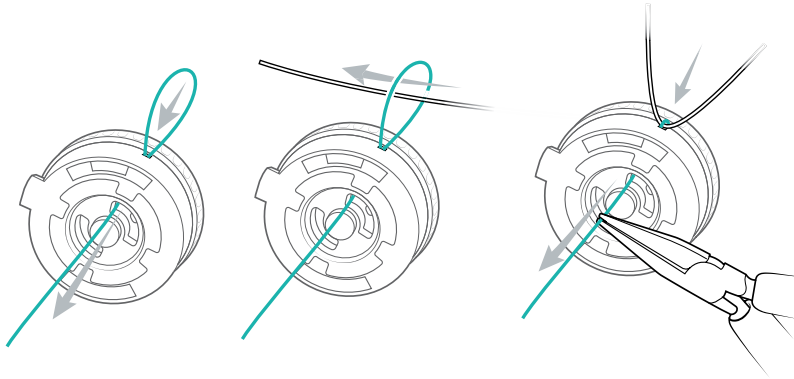

Step 4

Tie a **double overhand** knot and trim tail to ~5mm and lightly burn the end of the tail.

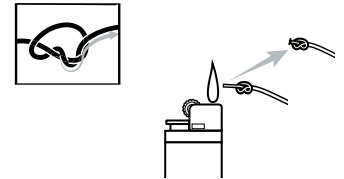

Step 5

Pull lace to seat knot in the far lace pocket, on the opposite side of the green marker.

Completely push knot into the cavity with a #1 flathead screwdriver:

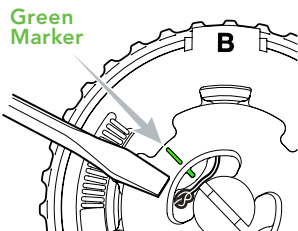

Step 6

Pull open lace end to remove loose lace from device.

Repeat Step 3 to feed open lace end through reel.

Measure out ~10cm of lace.

Repeat Step 4 to tie double overhand knot, trim and seat it.

Step 7

Decide which reel mode to activate:

For more information on reel modes, watch our video here: <https://vimeo.com/786989811>

ADJUSTABLE DESIGNS WITH
Less than 3" of lace uptake

75% of Applications

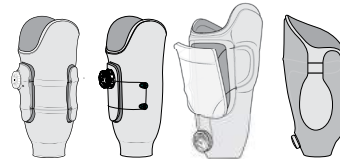

Keep Red Lock Plugs installed in the reel.

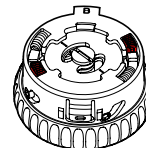

ADJUSTABLE DESIGNS WITH
More than 3" of lace uptake

25% of Applications

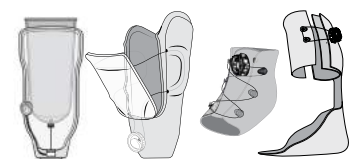

Remove Red Lock Plugs after lacing the reel.

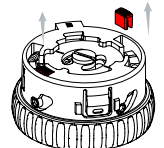

Pro Tip: Central fabricators should deliver device with Red Lock Plugs installed in reel. This will allow the practitioner to decide if they want Power Mode or Shift Mode.

18 Install the Click Reel:

1. Insert the foot of the reel into the void in the bottom of the collar opposite of the metal insert.
2. Press the reel firmly into the collar (you should hear a "CLICK" when secure).

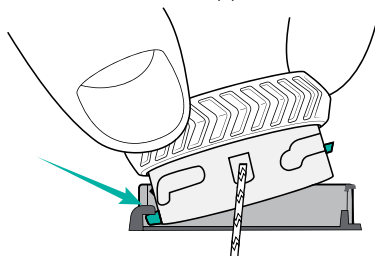

19 Test function.

Cycle the system 3 times before delivering to verify proper function.

20 Important.

As a final step of fabrication, attach the patient **Instructions For Use** hangtag on dial.

How to use the Click Reel

The reel can operate in either Power Mode or Shift Mode.
If you want to change between modes, see our video on the process here: <https://vimeo.com/786989811>

How to operate the Click® Reel in **Power Mode - With Red Lock Plugs**

- 1 Turn the dial clockwise to tighten to desired tension.
- 2 Turn the dial counterclockwise to release tension.
- 3 Micro-adjust as needed.

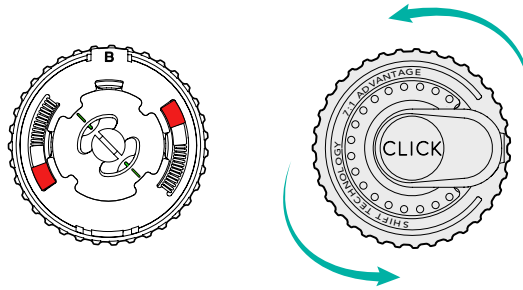

If the reel always clicks when turned, it is in Power Mode

How to operate the Click® Reel in **Shift Mode - Without Red Lock Plugs**

- 1 Turn reel clockwise to quickly take up lace.
- 2 Continue to turn the dial. It will automatically shift from "silent" to "clicking".
- 3 Micro-adjust by turning forward or backward.
- 4 To fully release lace, unwind counterclockwise until "clicking" stops. Lace will then freely release from the reel.



Reel will operate silently while taking up lace



Once clicking, the reel will hold lace tension and wind up lace at a higher power



Teach your patients how to release and reconnect the releasing guides:

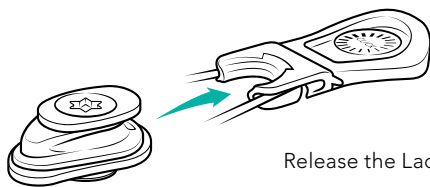

Release the Lace.

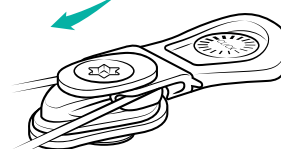

Reconnect the Lace.

To remove the Click Reel:

1. Locate the metal insert.
2. Insert a small #1 flathead screwdriver between the metal insert and the reel body.
3. Gently pry the reel upwards.

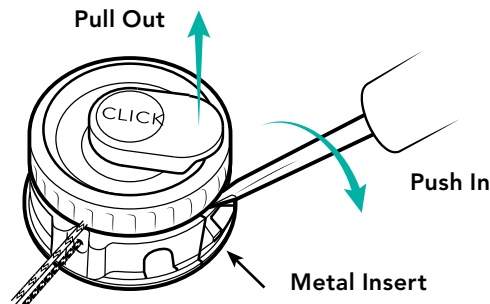

See clickmedical.co/instructions for detailed instructions for replacing/re-lacing a reel.

At delivery of device with patient present, scan *Instructions For Use* Hangtag. Please review with your patient how to use the Click Reel and to care for and maintain their RevoSurface system.

Regularly inspect your RevoSurface system.



Inspect lace:

- ✓ Check for wear or damage routinely
- ✓ Replace at any sign of wear
- ✓ Replace lace every 6 months



This product is waterproof and submersible. Rinse with fresh water after use in saltwater, sand, or mud.

UK REP

MDSS-UK RP LIMITED, 6 Wilmslow Road
Rusholme, M14 5TP Manchester
United Kingdom

CH REP

MDSS CH GmbH, Laurenzenvorstadt 61
5000 Aarau, Switzerland

MD
EC REP

MDSS GmbH, Schiffgraben 41
30175 Hannover, Germany



Click Medical, LLC, 1205 Hilltop Parkway, W101
Steamboat Springs, CO 80487, USA +1-970-670-7012